

2 Diodes and Transistors

Student Group

First Name	Surname	Matrikel Nr.

Table of Contents

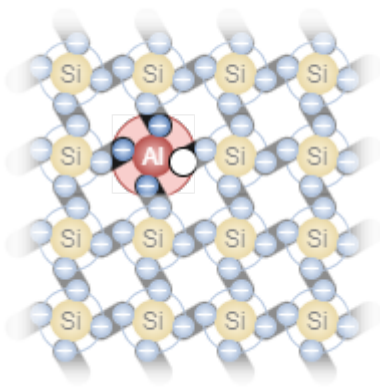

Bohr atomic model

1a

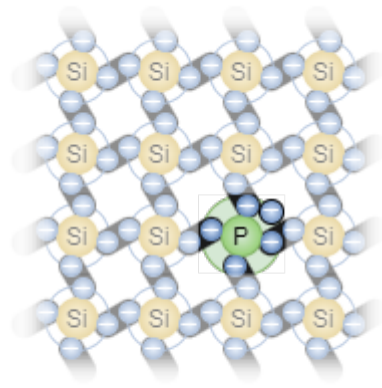
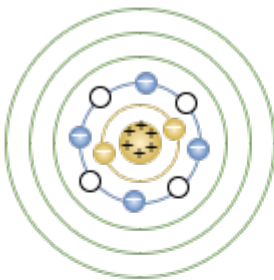

1b

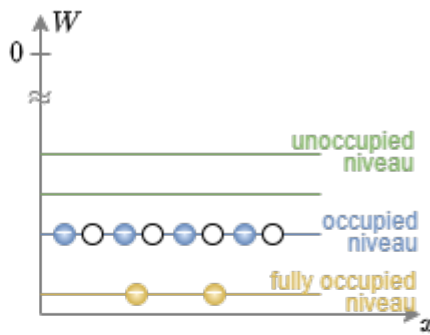

2a

Band model

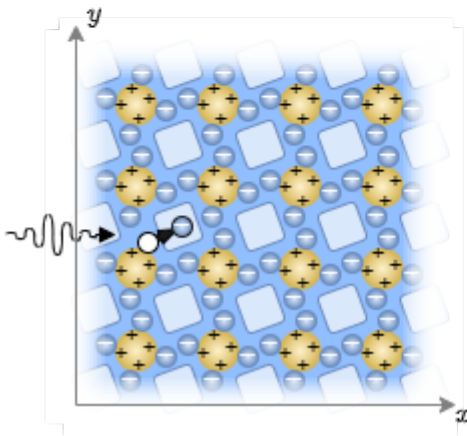

2b

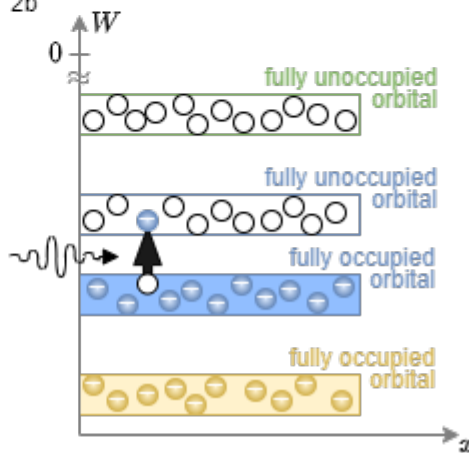

	a)	b)	c)	d)
1. Intrinsic				
2. n-Doped				
3. p-Doped				

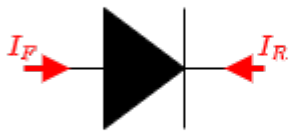

IEEE

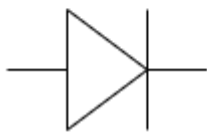

DIN/EN

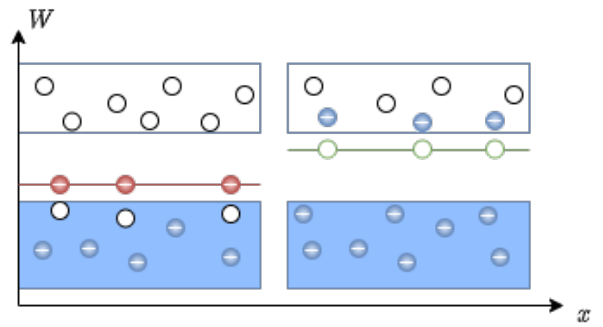
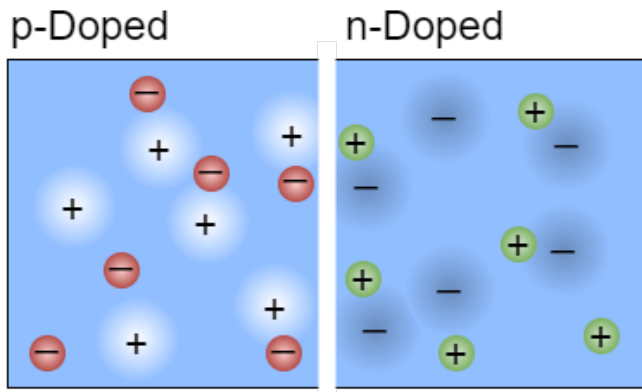

Recombination

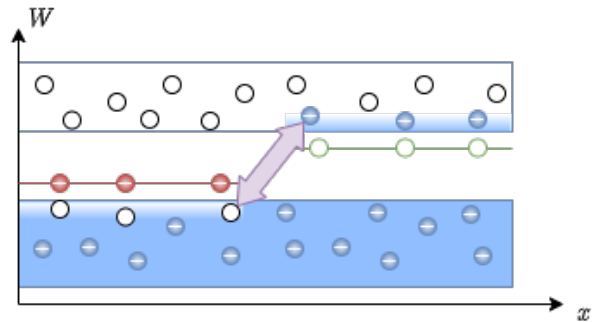
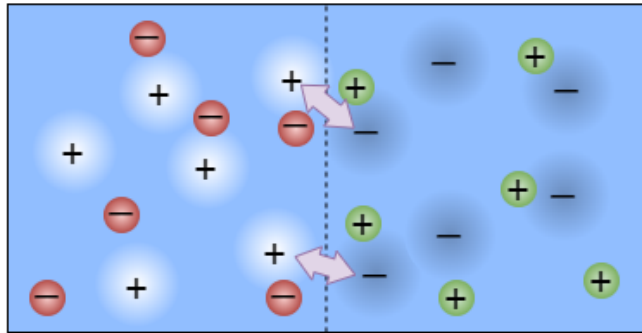

Depletion Region

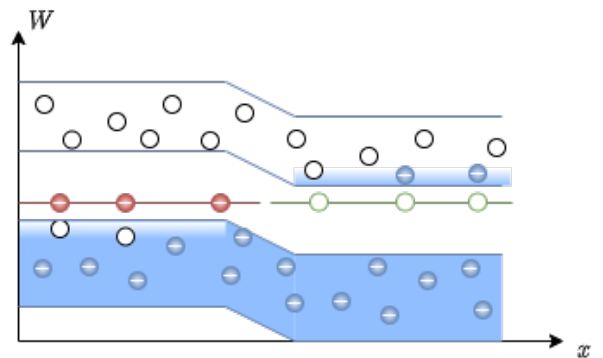
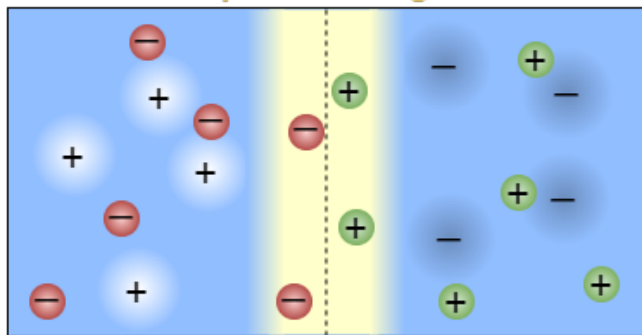

without external Voltage

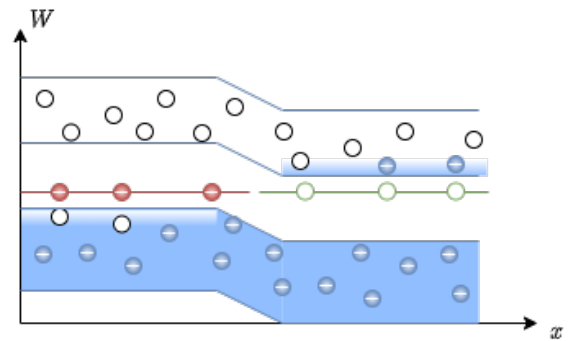
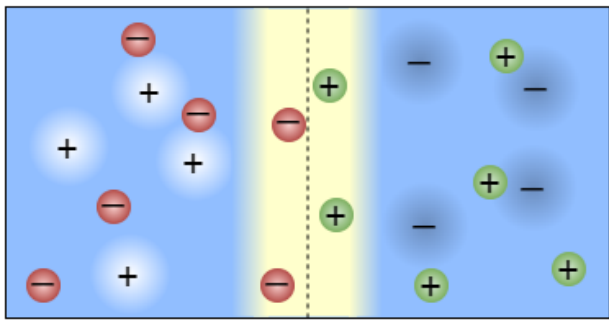

with $U_F > 0$

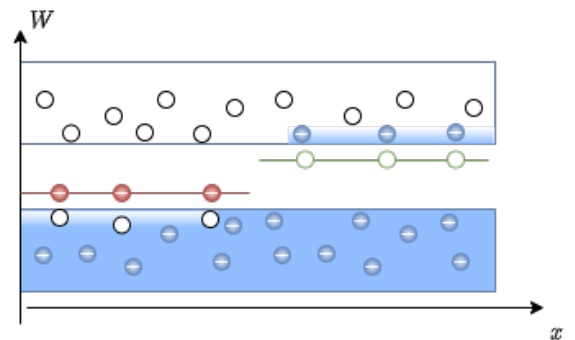
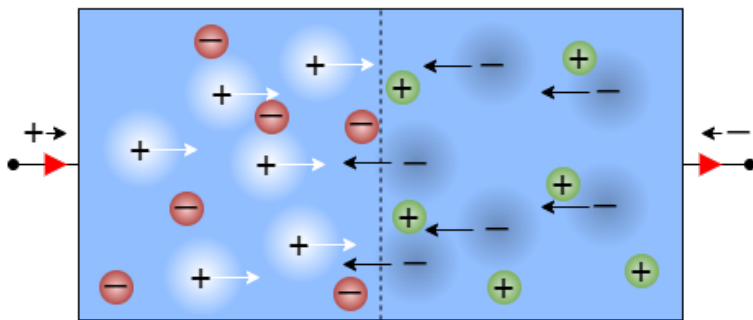

pn Junction with steep Doping

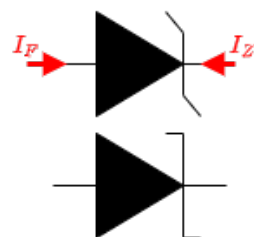
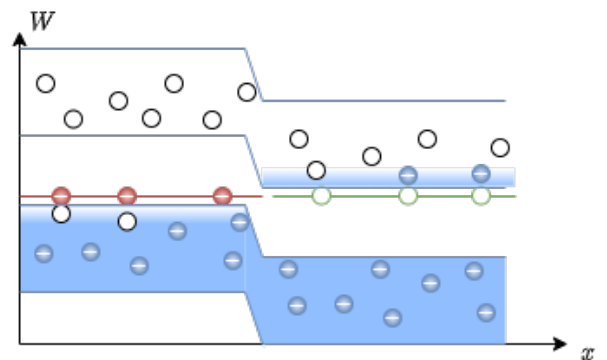
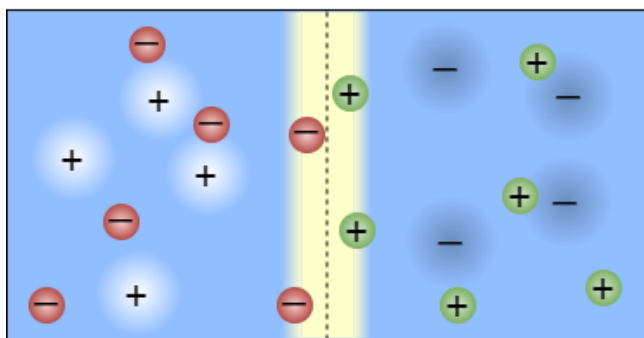

IEEE

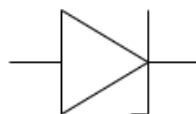

DIN/EN

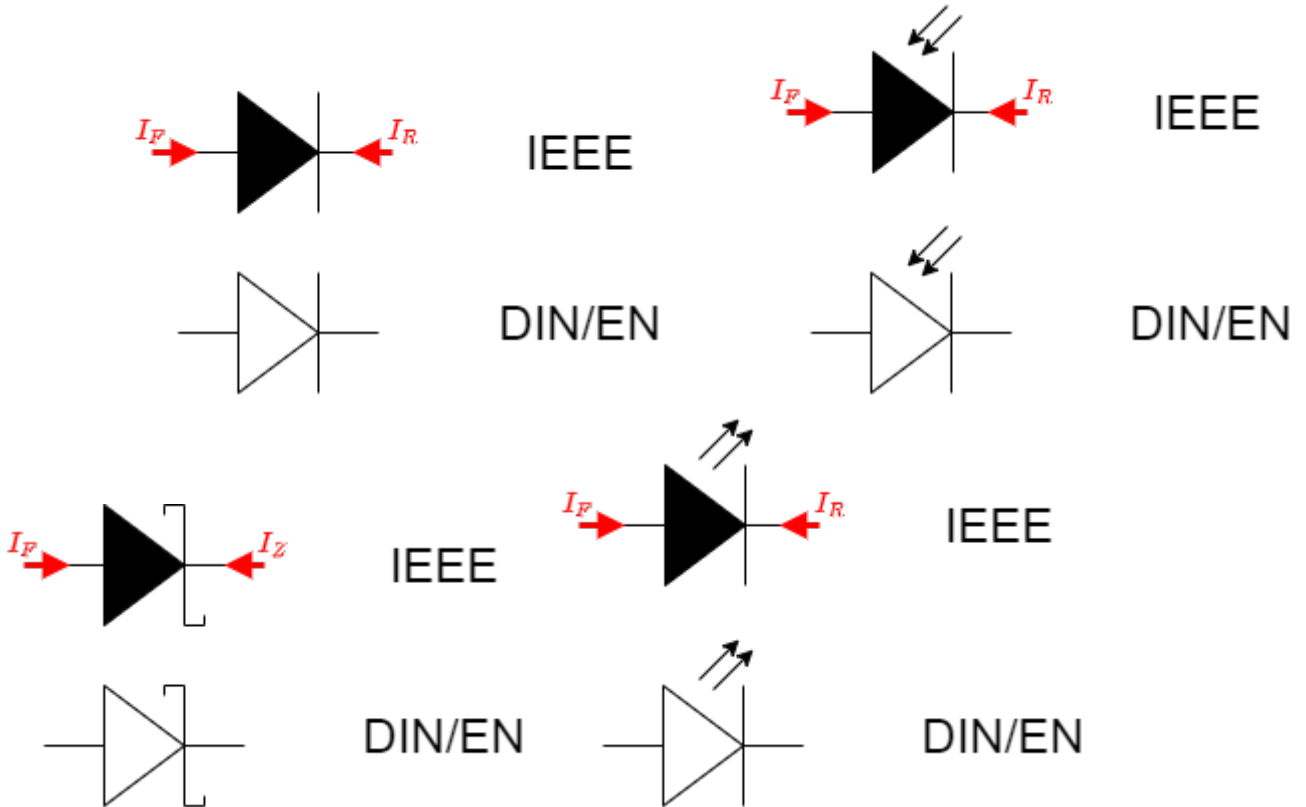
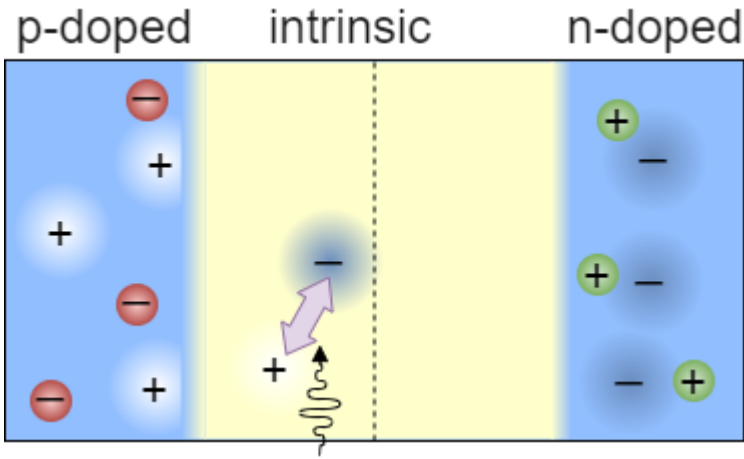

From: <https://first.mexle.te.hs-heilbronn.de/> - MEXLE Wiki

Permanent link: https://first.mexle.te.hs-heilbronn.de/circuit_design/2_diodes?rev=1636846877

Last update: 2021/11/14 00:41

